

N5BRG 10 GHz Station

October 3rd, 2015

10 GHz Station

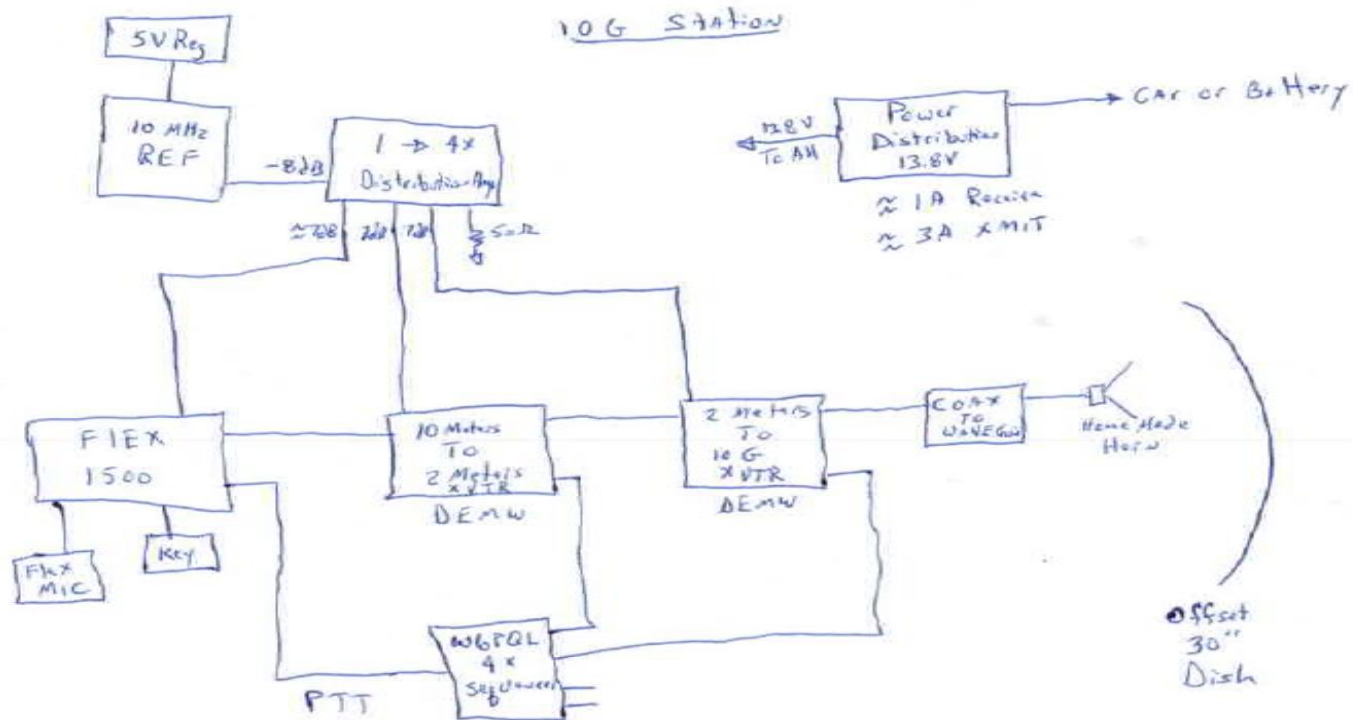
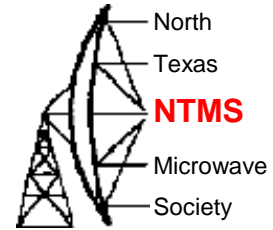

N5BRG
10/3/15

10 GHz Reference Oscillator

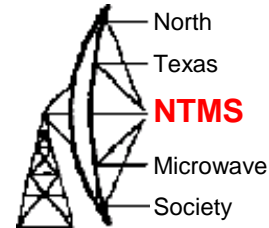

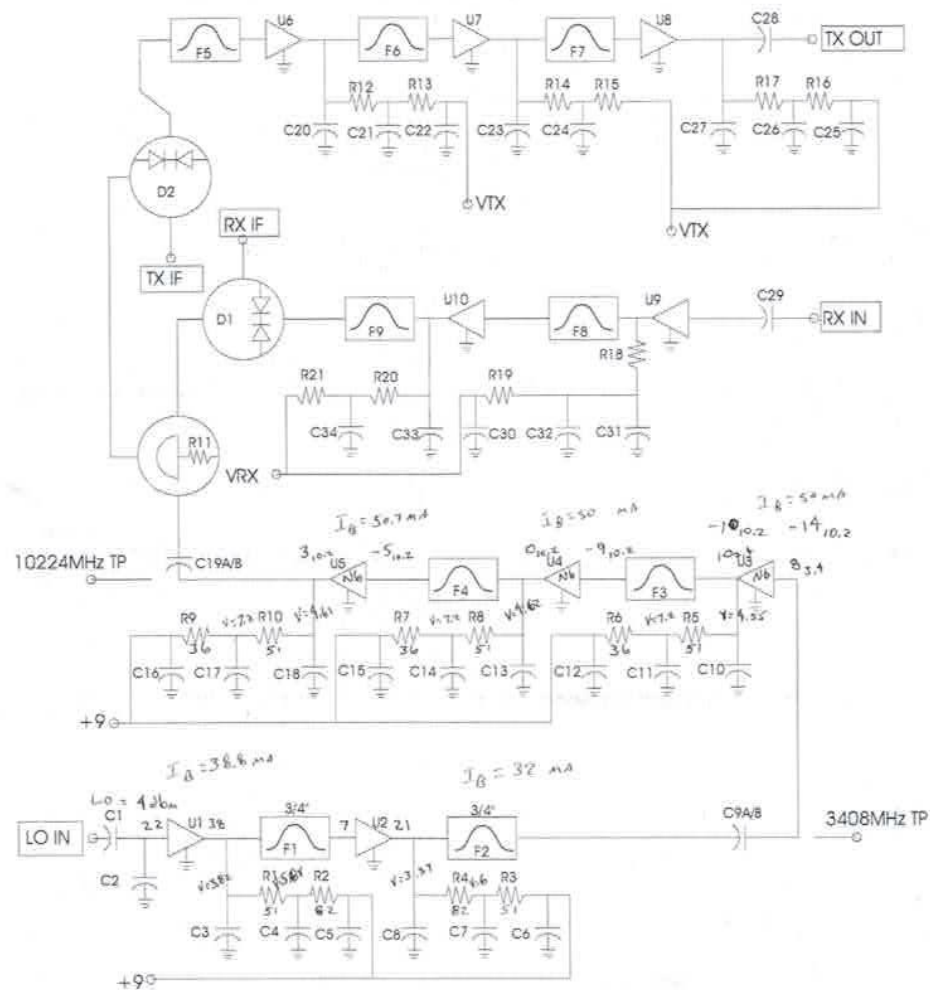
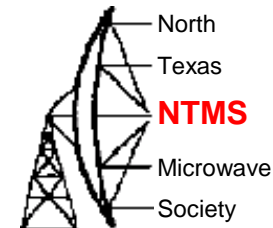

10368-144LP TRANSVERTER SCHEMATIC

N5BRG Rover Setup with Flex-1500

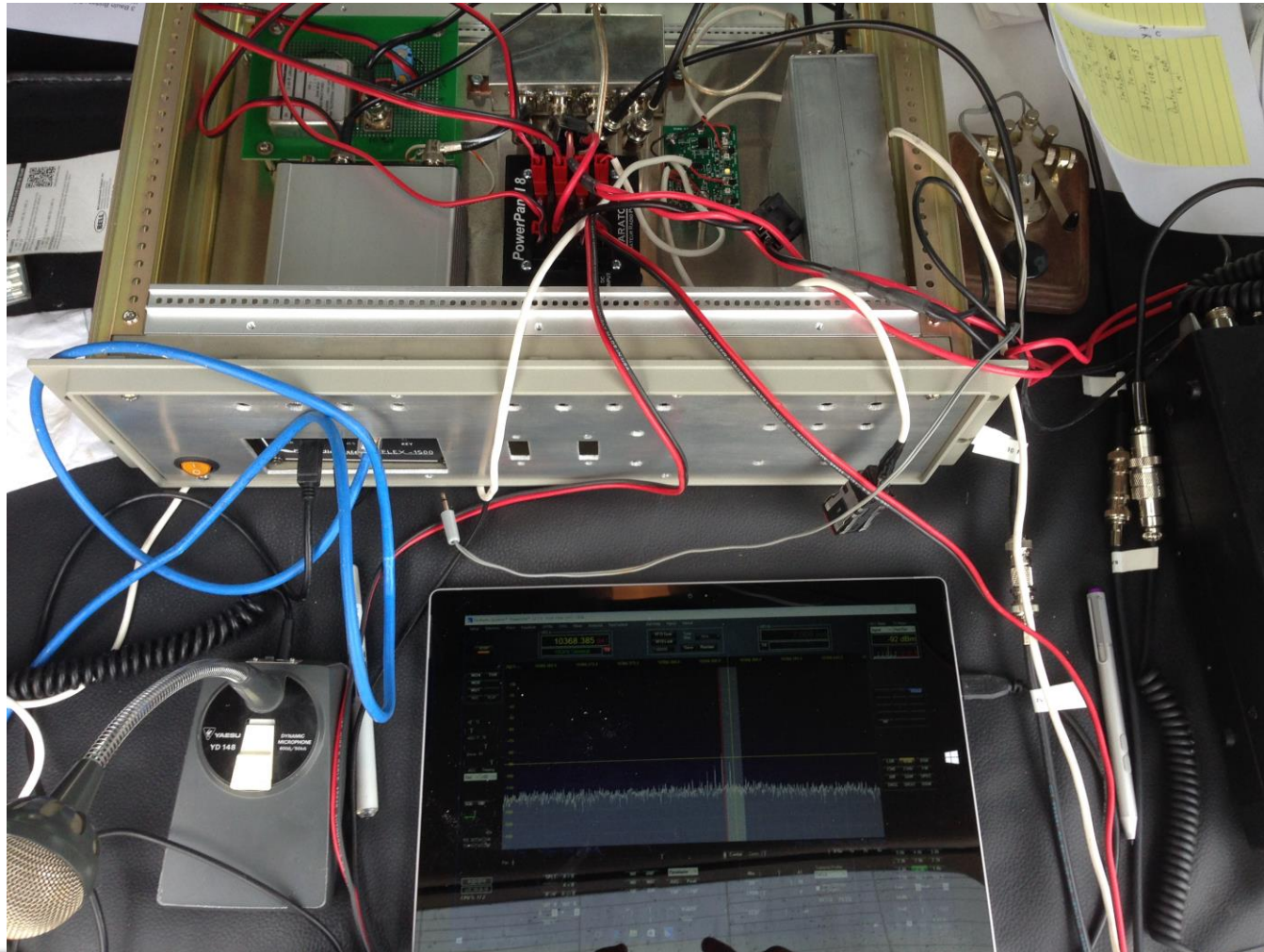
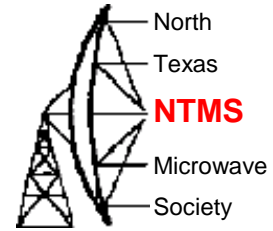

N5BRG operated from EM13mj and EM13il

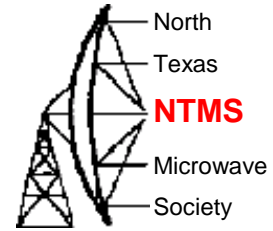

10 GHz Signal

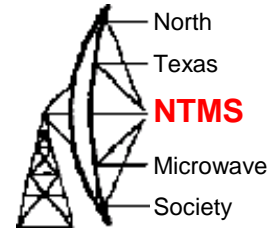

Signal purity with low drive to A-32. This plot was improved with increased 10 MHz drive to A-32